

Fitness

**Solutions for the fitness industry
40% less costs, 80% less weight,
100% less maintenance**



• plastics for longer life®

igus®.eu...

www.igus.eu/fitness



Get in shape
quickly without
lubricants!
40% less costs,
80% less weight
and 100% less
maintenance

Your cost reducer and technical innovator,

Michael Hornung

Product Manager

drylin® linear and drive technology

Phone: +49 2203 9649-156

e-mail: mhornung@igus.de

www.igus.eu/fitness



Fitness equipment is adjusted for the next user in a very short time. Seat position, operating elements, weights and inclination are only a few of the adjustments on sport equipment.

These adjustments can be made manually, or electrically at the press of a button. In every case, the movement should be smooth, quiet and soft - over and over again.

The use of igus® bearings and linear systems offers the user a comfortable, high-quality feeling in the adjustment and due to the freedom of lubrication, all bearing points are clean and rugged. Because of the sliding motion and elimination of balls, all movements are almost completely silent. Whether linear guides or bearings - igus® offers all components of traditional drive technology as lubrication-free version. They are based on technical plastics that do not require lubrication. The type of movement, which is simpler compared to re-circulating steel balls, reduces noise and weight while reducing costs by 40%.

For the manufacturer and the operator of fitness equipment, this freedom from lubrication means that tedious re-lubrication is a thing of the past and also that a dusty environment is no longer detrimental to function.

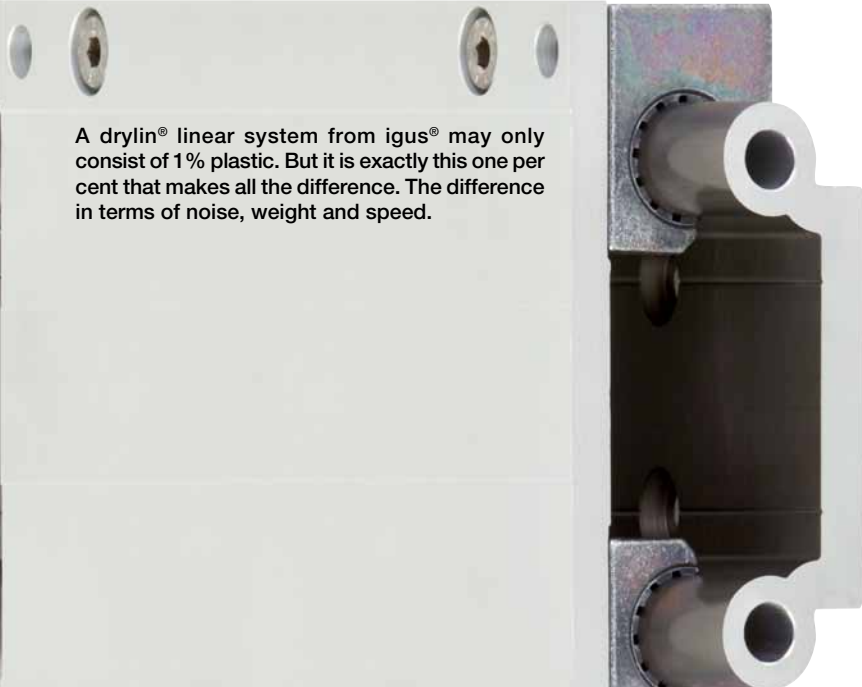

A drylin® linear system from igus® may only consist of 1% plastic. But it is exactly this one per cent that makes all the difference. The difference in terms of noise, weight and speed.

Always stay active ...

... with well-designed igus® linear guides and bearings for sports equipment.

McFit, Fitness First or Kieser Training - currently, far more than ten million members are working out in German gyms, and the trend is rising. Statistics show that the services used most in gyms are fitness devices for weight training and cardio machines. Always in the focus: ergonomic and smooth movements.

To adjust sitting position, weights and inclination of the devices, we recommend bearings and linear systems by igus®. They are comfortable to handle and work almost silently. Especially at large sports facilities with several hundred exercise machines, it is important that noise generation is minimal. No less important: igus® products are lubrication-free. After all, no gym member wants to get dirty hands or oil marks on their stylish gym outfit.

In any case, for professional use exercise machines have to withstand continuous operation on a daily basis, whether they are adjusted manually or electronically at the push of a button. Light, quiet and soft movements - over and over again and with running performances of several hours a day. With bearings and linear systems by igus®, the professional models are equipped with the mechanical requirements to withstand these loads in the long term. The robust machine elements provide security and reliability for many years without failure. After all, there is nothing more annoying for the operators and members of a gym than faulty machines in the training area.

Advantages of igus® products for the sports, fitness & rehabilitation industry:

- 100% lubrication-free products for clean handling
- Corrosion-free, easy to clean
- Smooth and quiet operation
- Robust and compact
- Maintenance-free
- Low friction and wear
- Lightweight

motion?

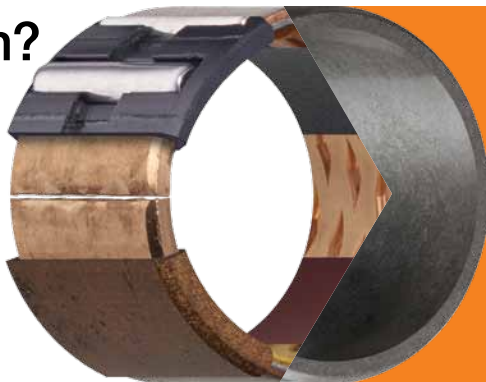

plastics!

... by igus®



www.wiqtus.eu/fitness

Fitness machine from EXER - precise and silent for the outdoors



Outdoor fitness equipment from EXER, Gustavo Evangelista, Turin, Italy

This fitness machine allows you to train your legs effectively. For this purpose, the user sits on a seat that slides back and forth while stretching and bending the legs. To provide users with optimal training success and to avoid any injury in the process, it is important that the seat moves fluidly. Since the leg press is used outdoors, bearings and guides must also be corrosion-resistant and at best lubrication-free. For this reason the developers used drylin® W hybrid bearings and two drylin® linear guides.



Resistant to weathering
and dirt:
iglidur® plain bearings and
drylin® hybrid bearings

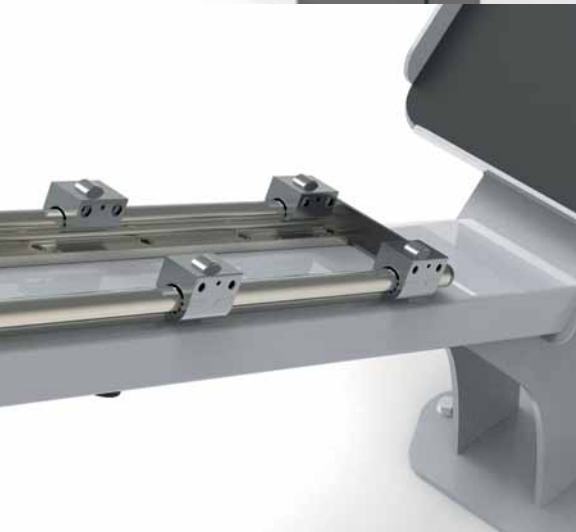

www.igus.eu/fitness

Fluid movement thanks to igus® drylin® linear in exercise equipment



Exercise equipment from ThoraxTrainer ApS, Ulrich Ghisler, Kokkedal, Denmark

With this training device, the cross-country ski trail comes into your living room. The user moves the sticks as in real cross-country skiing and thus achieves an optimal training effect for the entire body. It was important for the developers that the carriages slide very smoothly along the rail. In addition, the movement should make as little noise as possible, so that the equipment can be used easily in your own home. The prerequisites were easily achieved with a drylin® linear guide.

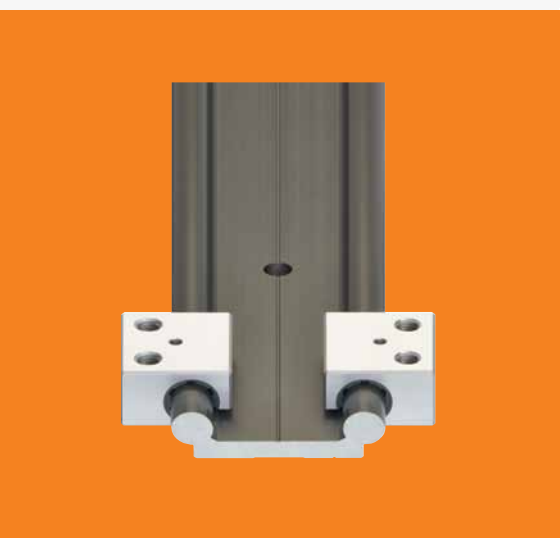

www.iguus.eu/fitness

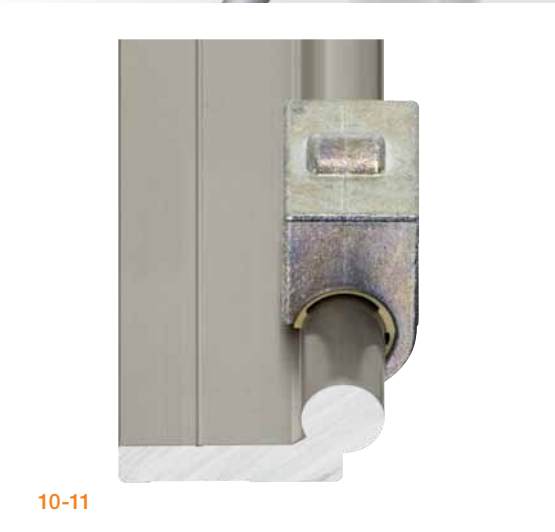
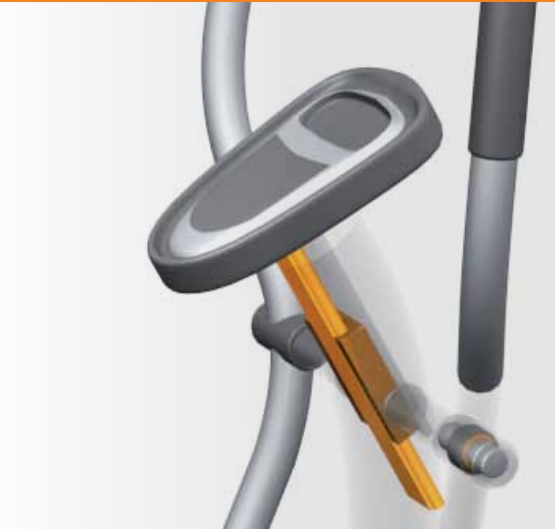

drylin® W in leg exerciser: virtually silent height adjustment

- Lubrication and maintenance-free
- Extremely quiet because bearings are eliminated
- Aesthetic design



www.igus.eu/drylinW

drylin® N in display adjustment: very smooth

- Very low coefficients of friction
- Quiet
- Very compact design



www.igus.eu/drylinN

drylin® W in seat adjustment: slide and roll

- Easy movement with roller support
- Wide range of sizes and versions
- High torsional stability



www.igus.eu/drylinW

iglidur® G in stepper: cost-effective and reliable

- Smooth running due to low coefficient of friction
- Reliable, maintenance-free and dirt-resistant
- Cost-effective



www.igus.eu/G

drylin® W in rowing machine: silent gliding of the seats

- Reliable and calculable
- Low vibration
- Resistant to dirt



www.igus.eu/drylinW

iglidur® D in seat adjustment: low-cost bearing

- Low coefficients of friction
- For low loads
- Cost-effective



www.igus.eu/D

www.igus.eu/fitness

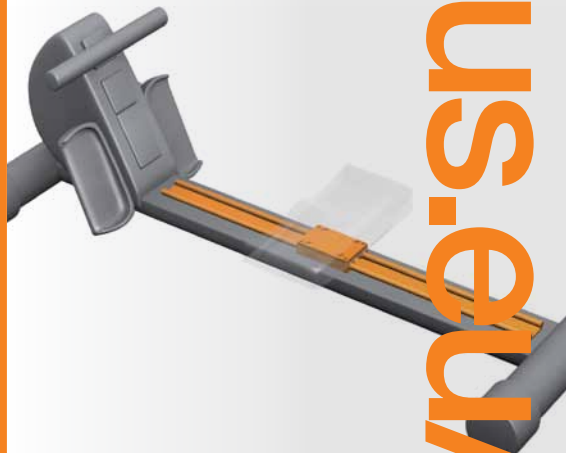



iglidur® J in handlebar adjustment: very easy to adjust

- Wear-resistant
- Low coefficient of friction, no squeaking (stick-slip)
- Resistant to edge loads



www.igus.eu/J

drylin® in treadmill: easy around the bend

- drylin® linear guide system on curved profile
- Variable profile directions
- Torque-resistant alternative to curved tube profiles



www.igus.eu/curved

drylin® R on the butterfly: guidance of the weights

- Robust and dirt-resistant
- Quiet and shock-dampening
- Maintenance-free



www.igus.eu/RJM

www.igus.eu/fitness

igubal® pillow block bearings in weight bench: safe training with igus®

- Lubrication and maintenance-free
- Fast assembly
- Reliable guidance of the weights



www.igus.eu/igubal

igubal® spherical bearing in cross-trainer: silent and cost-effective

- Absorbs vibrations
- Angle and tolerance compensation
- Lubrication-free and lightweight



www.igus.eu/igubal

iglidur® G in vibration fitness equipment: silent and maintenance-free

- Extremely wear-resistant
- Low coefficient of friction, no squeaking (stick-slip)
- Lightweight, lubrication and maintenance-free



www.igus.eu/G



www.igus.eu/fitness

iglidur® J3 in rowing equipment: silent and maintenance-free

- Rotating and pivoting adjustments
- Resistant to corrosion, high pressure cleaners and cleaning agents
- Lightweight, lubrication and maintenance-free



www.igus.eu/J3

iglidur® J in hand bike: safe and easy in open country

- Dust and moisture-resistant
- Lightweight
- Vibration-dampening



www.igus.eu/J

E2 micro e-chain® in the "rowing bike": guide energy in tight spaces

- Guidance of hydraulic brake cables and electrical cables with a stroke of 600mm
- Corrosion-free and lubrication-free
- Insensitive to rain, dust and dirt



www.igus.eu/E2micro



www.igus.eu/fitness

When it is all about fitness - igus® catalogue parts, special parts, bar stock and 3D-printed solutions



We can also go your way: customised solutions, special designs and special materials - (virtually) everything is possible.

The standard is not the right solution for everyone. Therefore, igus® also manufactures a number of customised special designs. Structural and material special solutions such as plain bearings for multiple-edge shafts, bearings with reduced clearance or anti-rotation feature, special lead screw support blocks and glide pads, and so on, are specially adapted to your requirements. Starting from medium quantities we make almost everything possible.



www.igus.eu/speedigus



3D printing service - for custom-made parts made of high-performance plastics.

In two simple steps to the 3D-printed component - with instant price. We print your individual component, using lubrication-free, abrasion-resistant iglidur® high-performance plastics. Upload your drawing in the STEP format, check the 360° view and select a material. We ship your desired product - depending on the complexity - from 24 hours.





Tested ...



- Test: pivoting wear rate
- Load per bearing point: 25N to 300N
- Surface speed: 0.01m/s

Tested ...



- Simulation of continuous load
- Tested with impact
- In suspended parallelogram seat post



Tested ...



- Test: linear wear rate
- Load per bearing point: 10N to 200N
- Surface speed: 0.1m/s up to 0.3m/s



Test rig pivoting wear

Extensive
test data-
base

Tested ...



- Test: service life of lead screw nuts
- Load: 25N to 50N
- Speed: up to 1m/s



Test rig linear wear
(short stroke)

From more than 15,000 tests per year was created, what is probably the world's largest test database. This database gives us the ability to always select the right product for your specific application. Individual tests for your industry are also possible.



www.igus.eu/test

www.igus.eu/fitness

igus®.eu/24

Buy online - 24hrs!

Visit our industry web page for more information, products, application examples and useful online tools. Quickly find and configure products and calculate service life - all online. With the help of our product finders, you can quickly find the right article and obtain an exact prediction of service life. All online tools also enable you to reduce process costs. igus® delivers from stock in 24-48 hours!

The screenshot shows the igus.eu website interface. At the top, there is a navigation bar with links for Products, Configurators, Industry Solutions, Service, Company, myigus, and Shopping Cart (0). Below the navigation bar, there is a main banner with the text "Get in shape quickly without lubricants" and an image of a person running on a treadmill. To the right of the banner, there is a "Your contact" section featuring a profile picture of Michael Hornung, his name, phone number (+49 2203 9649 156), and a link to "Your requirements?". Below this, there are links for "myigus" and "myCatalog". A list of service options includes "No minimum order value", "2nd - 20th Delivery/Consultation", "Delivery from 24h*", "Free samples", and "Is something not to your liking? / Feedback". There are also links for "Newsletter Registration", "Terms and Conditions", "Imprint", and "General information".

Always stay active ...
... with well-designed igus® linear guides and bearings for sports equipment

Change bearing now and reduce costs by up to 40%

McFit, Fitness First or Knieer Training – currently, far more than ten million members are working out in German gyms, and the trend is rising. Statistics show that the services used most in gyms are fitness devices for weight training and cardio machines. Always in the focus: ergonomic and smooth movements. To adjust sitting position, weights and inclination of the devices, we recommend bearings and linear systems by igus®. They are comfortable to handle and work almost silently as they operate without balls. Especially at larger sports facilities with several hundred exercise machines, it is important that noise generation is minimal. No less important: igus® products are lubrication-free. After all, no gym member wants to get dirty hands or oil marks on their stylish gym outfit. In any case, for professional use exercise machines have to withstand continuous operation on a daily basis, whether they are adjusted manually or electronically at the push of a button. Light, quiet and soft movements ... over and over again and with running performances of several hours a day.

Advantages of igus® high performance polymers for the sports, fitness & rehab industry:

- Maintenance-free dry operation, no grease
- Low coefficients of friction
- Smooth and quiet operation
- Corrosion-free, easy to clean
- Absorbs vibrations
- Low wear

Get in touch with us now!

igus® in exercise machine: maniss® application, which has been awarded gold, brings the cross-country skiing trail to your home.

Always the right solution for the sports and fitness industry.

igus® is certified in accordance with ISO 9001:2015 and ISO/TS 16949:2016 in the field of energy supply systems, cables and harnessing, as well as plastic bearings.

igus® GmbH
Spicher Str. 1a
51147 Cologne
Phone +49 2203 9649-145
Fax +49 2203 9649-334
info@igus.eu
www.igus.eu

igus®.eu

© 2018 igus® GmbH
Published by igus® GmbH, Germany
MAT0073311.20 As of 04/2018
Subject to technical alterations.

www.igus.eu/fitness